



Laboratory Equipment Manufacturer  
www.mrclab.com



# Operation Manual for Microplate Washer **UT-3100**



**PLEASE READ THIS MANUAL CAREFULLY BEFORE OPERATION**

3, Hagavish st. Israel 58817 Tel: 972 3 5595252, Fax: 972 3 5594529 mrc@mrclab.com

**MRC.VER.01-9.12**

## How to use this manual

**It's greatly appreciated you become the user of Microplate Washer.**

Be sure to read this manual carefully before operating the instrument.

In order to obtain the best result, it is important for you to get familiar with our instruments and their functions before performing clinical diagnostic tests.

This User's Manual is the operation instructions for Microplate Washer, which including the contents of instrument installation, daily use, and maintenance etc.

Please reserve all the packing materials for the use of deposit, transportation and maintenance in the future.

You may contact with your distributor if there is any problem.

**As to the instruments of different version or configuration, their functions are slightly different.**

**Notes:** *Tips, advices and suggestions will be presented in italics for distinction.*

**Warning: The warning shall be strictly abided by in order to ensure that the instrument may works normally and the test results may be correct and authentic. Black letters are adopted for distinction.**

## Symbols on the instrument



This symbol means that the labeled item is hot while the instrument is in use. Don't touch the labeled item as you could be burnt. The symbol is labeled on the lamp support of optic system.



This means that the labeled item could lead to personal injury and/or damage to the analyzer. The symbol is labeled beside the power outlet and some external interface.



The symbols for "SERIAL NUMBER", The serial number shall be after or below the symbol, adjacent to it.



The symbol means the product is in vitro diagnostic medical device.



The symbol indicates the manufacturer and its address, after which are shown its name and address.



The symbol indicates the date of manufacture, after which are shown its manufacture date.



The symbol indicates EU representatives of the manufacturer and their addresses, after which are shown their names and addresses.



The symbol indicates biological pollution, marked in the part where the instrument contacts the clinical reagent. The symbol appears in black side and yellow background.



The symbol means that the environment of instruments must be damp proof in the course of transport, and instrument must be kept in a dry environment.



This means that instrument should handle with care in the course of transportation, so as not to damage it.



The symbol means the instrument packaged should not be upended at any time

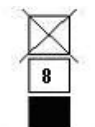

The symbol means that the level piled up can't exceed 8 layers, as not to damage instrument.



The symbol indicates temperature range of the analyzers during storage and transportation.

## Warning and Safety Indications

This instrument is only used for in vitro diagnosis, please carefully read the following warnings before the usage, and strictly obeys them.

---

- The articles and materials used by some test items have biological danger. Be sure to wear the protective clothing and the glasses when operating the instrument, and put down the protection cover.
  - Some steel pins of the wash head are sharp, so touching them may lead to bodily injury. Don't put your hand or finger in the area of the worktable when the instrument is in motion. Be sure to turn off the power before replacing the wash head. It is forbidden to touch the wash head when the instrument is in motion.
  - When the instrument is in motion, be sure to turn off the power switch at once if the waste bottle is turned over. At this moment, the instrument probably discharges a small amount of waste liquid through a device in the bottom, and this waste liquid must be dealt with according to the biological dangerous cargo.
  - When the incubator is being heated, don't touch the incubation plate by hand in order to avoid or prevent scald; furthermore, the incubator adopts high-voltage power supply, so it is forbidden to contact the incubation plate with hand or such conducting objects as ironware etc. when the instrument is in motion in order to avoid electric shock.
  - Please wear the rubber gloves while carrying out maintenance; please wash your hands to avoid virus infection after each operation finishes.
  - Don't let hands or other positions of body touch the reagent or the patient's sample, if the wounded part touches the patient's sample carelessly, please wash it timely and see a doctor for examination.
  - Blocked wash head will cause bad aspiration and dispensing. In this case please rinse the wash head with distilled water, and then dredge the blocked hole with a thin pin. If the problem can not be solved this way, you need to replace the wash head.
  - The product is a bench-type testing device, without issues on taboo.
  - The ground wire of the power line of this instrument has ground connection to avoid electric shock. The ground wire has to be connected to ground.
  - The AC electric supply must be stable, and is forbidden to share the power with high-power electric apparatus.
  - While pulling out the power line, be sure to catch the plug, but not the power line.
  - Turn off the power supply immediately and contact the seller if the instrument gives out smog, peculiar smell or strange sound.
  - Be sure to cut off the power supply and switch off the main processor when carrying out maintenance or dismantling the outer cover due to other reasons.
  - Pharmaceutical affairs law and regulation: it is forbidden to refit the medical instrument.
-

## Content

How to use this manual .....	1
Symbols on the instrument .....	2
Warning and Safety Indications .....	3
1. Brief introduction of the instrument .....	6
1.1 Brief introduction of product .....	6
1.1.1 Name of the product: Microplate Washer .....	6
1.1.2 Features of the product .....	6
1.2 Specifications of the instrument .....	7
1.3 External structure .....	8
1.4 Keyboard .....	9
1.5 Principle of the instrument .....	10
2. Installation of the instrument .....	11
2.1 Unpack .....	11
2.2 Install the bottles and tubing .....	11
2.3 Install the wash head .....	12
2.4 Start the instrument .....	12
3. Settings and adjustment of the instrument .....	13
3.1 Advanced settings .....	14
3.1.1 Adjust the LCD contrast ratio .....	14
3.1.2 Hang-up settings .....	14
3.1.3 Plate shaking .....	15
3.1.4 Stroke settings .....	16
3.1.5 Aspirate pump speed settings .....	16
3.2 Plate settings .....	17
3.3 Switch bottle .....	19
3.4 Turn off the system .....	20
4. Operation of the instrument .....	21
4.1 Worktable and ELISA plates .....	21
4.2 Washing the plates .....	21
4.2.1 Parameter confirmation .....	21
4.2.2 Parameter settings .....	22
4.2.3 Plate washing .....	24
4.3 Single aspirate / single dispense .....	26
4.3.1 Single aspirate .....	26
4.3.2 Single dispense .....	26
4.4 Prime / Rinse .....	28

4.4.1 Prime .....	28
4.4.2 Rinse .....	28
4.5 Incubator .....	30
4.5.1 Parameter settings .....	30
4.5.2 Incubation process .....	30
5. Maintenance .....	32
5.1 Regular maintenance of the worktable .....	32
5.2 Regular maintenance of the wash head .....	32
5.3 Replacement of the fuse .....	32
5.4 Treatment of the waste bottle .....	32
6. System error and solutions .....	34
Declaration .....	35

## **1. Brief introduction of the instrument**

### **1.1 Brief introduction of product**

#### **1.1.1 Name of the product: Microplate Washer**

#### **1.1.2 Features of the product**

- 1) English operating system, large screen liquid crystal display and graphic interface.
- 2) Support for single and three-channel wash system apply to washes flat, U and V bottom ELISA plates and strips as well as standard 96-well or other types of plates.
- 3) Convenient programming, wash time, liquid volume and soak time programmable. Plate washing, row washing and row-skip washing available.
- 4) Automatic positioning. Manual positioning to ensure the precision.
- 5) The design of double-pin wash head reduces cross contamination.
- 6) Wash and waste bottles have autoalarm function with liquid-surface detecting.
- 7) 8 and 12 way wash head available.
- 8) Incubation function (optional).

## 1.2 Specifications of the instrument

Wash head:	8-way or 12-way
No. of wash profiles	10
Capacity of the storage bottle:	Wash bottle, distilled water bottle and waste bottle, 2L each bottle respectively
Washing protocols	100
Washing cycles	Max. 99
Soak / shaking time	0-24 h
Mode	Plate & strip wash
Accuracy:	+/- 5%
Residual volume	< 1 $\mu$ l
Washing volume	10-3000 $\mu$ l / well
Resolution	1 $\mu$ l
Incubator temperature	25°/ 30°/ 37.0°C fixed
Temperature accuracy	+/- 5 %
Temperature stability	+/- 5 %
Temperature uniformity	+/- 1 °C
Warm-up time	6 min. ( ambient 25 °C to room temperature)
Display	Liquid crystal display
Interface	RS-232 bi-directional communication port
External dimensions	450mm(L)×390mm(W)×190mm(H)
Weight	13kg
Power supply	a.c. 220V, 50Hz
Input power	80VA
Working environment	10°C~30°C, Relative humidity ≤70%
Fuse	T3.15AL 250V, $\Phi$ 5×20



### 1.3 External structure

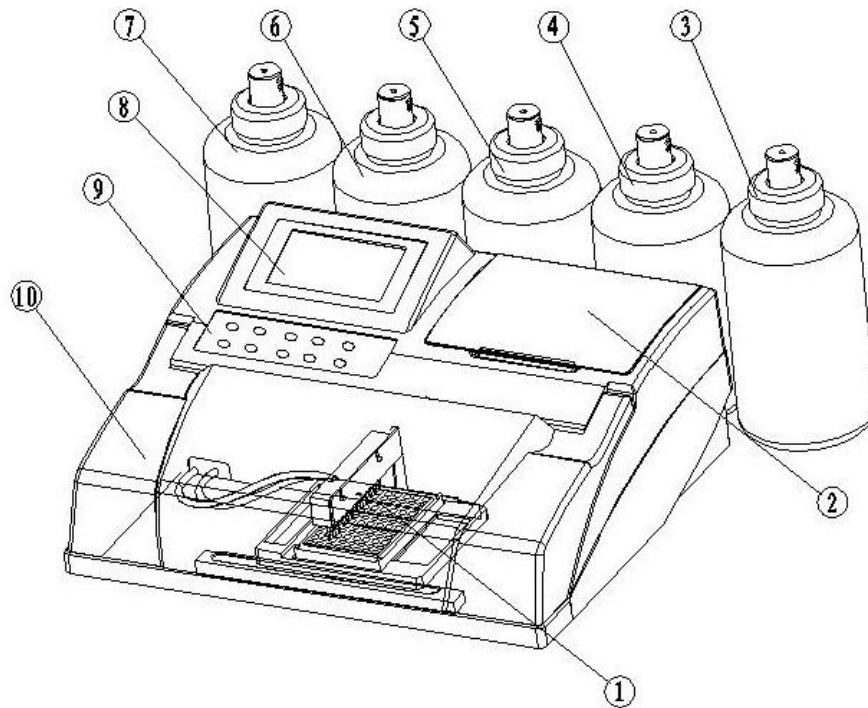

Fig. 1-1 Front view of instrument

1	ELISA plates	6	Wash bottle 3
2	Incubation cover	7	Distilled water bottle
3	Waste bottle	8	LCD screen
4	Wash bottle 1	9	Keyboard
5	Wash bottle 2	10	Transparent cover

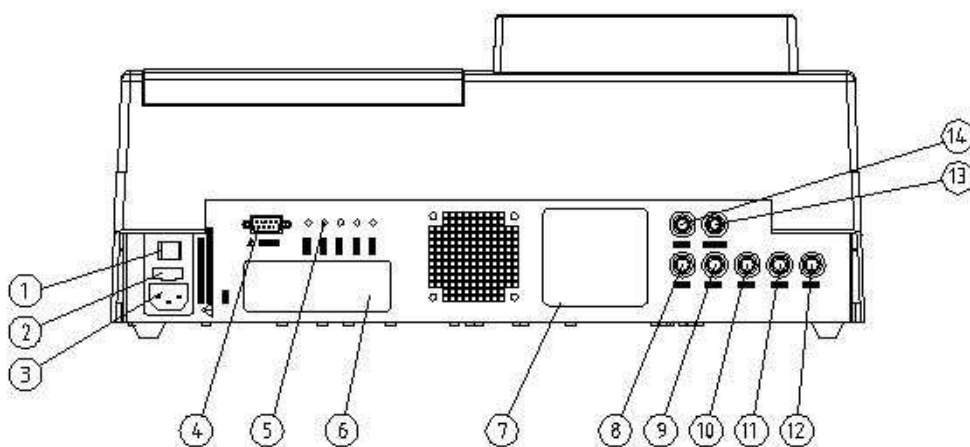

Fig. 1-2 Back view of the instrument

1	Power switch	8	Interface 1 of waste bottle
2	Fuse	9	Interface of wash bottle 1
3	Power inlet	10	Interface of wash bottle 2
4	RS-232 interface	11	Interface of wash bottle 3
5	Sensor interface	12	Interface of distilled water bottle
6	Label	13	Air vent
7	Wiring diagram of tubing	14	Interface 2 of waste bottle

## 1.4 Keyboard



Fig. 1-3 Schematic diagram of keyboard

START	Start a process; Save the parameter modifications.
CANCEL	Cancel the current operation; Discontinue the underway treatment; Cancel saving and quit the parameter modification.
^	Upwards
v	Downward
+	Change the parameters (increase, upwards, left)
-	Change the parameters (reduce, downwards, right)
PRIME	Start the priming procedure (shortcut key)
SELECT	Switching between rough adjustment / fine tuning
RINSE	Start the rinse procedure (shortcut key)
ASPR	Start the single aspirate / single dispense procedure (shortcut key)

## 1.5 Principle of the instrument

Microplate Washer is composed of a wash bottle, a liquid aspirate pump, a wash head, a vacuum pump and a waste bottle. Certain volume of the liquid in the wash bottle is pumped by the liquid aspirate pump, and then evenly dispensed into the microplate by the wash head; after special treatment such as soak and shaking, etc. the waste liquid is pumped to waste bottle by vacuum pump. Meanwhile, three wash channels of the instrument are automatically switched over by a solenoid valve, and are controlled in real time by a relevant liquid surface sensor which can feed back the liquid surface status of the current working bottle.

The wash bottle, liquid aspirate pump and dispensing pin (thin metal pipe of the wash head) make up the dispensing routes of Microplate Washer; dispensing of the three kinds of the wash liquid and the distilled water is controlled by four corresponding solenoid valves respectively.

The liquid aspirate pin (relatively thick metal pipe of the wash head), the waste bottle and the vacuum pump make up the draining routes of Microplate Washer. The negative pressure generated by the vacuum pump reaches the liquid aspirate pin via the waste bottle while the liquid within the microwells gets into the waste bottle under the atmospheric pressure.

## 2. Installation of the instrument

First of all, for Microplate Washer, prepare a place which meets the following requirements:

- Environment temperature 10°C-30°C;
- Relative humidity ≤70%;
- No direct sunlight or high dust concentration;
- No electro-magnetic radiation;
- With a sufficiently big, smooth and firm tabletop.

### 2.1 Unpack

Unpack the package and transportation materials of the instrument. Keep the packing box and packing material for future storage and transportation over again.

- Take out the packing list, and check the accessories;
- Take out the instrument.

---

***Note: Keep the packing box and packing material for future storage and any later transportation. Please contact the distributor if any accessory is missing.***

---

### 2.2 Install the bottles and tubing

Open the packing box of bottles, and take out the bottles, tubing, alarm signal line, etc.

- Install the bottle: Towards the rear side of the instrument, from left to right sequentially put the waste bottle, wash bottle 1, wash bottle 2, wash bottle 3 and distilled water bottle, as shown in Fig. 1-1 and Fig. 2-1.
- Connect the tubing: As shown in Fig. 1-2 and 2-1, towards the rear side of the instrument, from left to right, connect the tubing of the waste bottle, wash bottle 1, wash bottle 2, wash bottle 3 and distilled water bottle according to the sequence of the bottles; Among them, the negative pressure port of the waste bottle is connected on the top of the tubing (corresponding to the same interface color).
- Connect the signal line: As shown in Fig. 2-1, in the face of the rear side of the instrument, from left to right, connect the signal lines of the waste bottle, wash bottle 1, wash bottle 2, wash bottle 3 and distilled water bottle according to the sequence of the bottles.

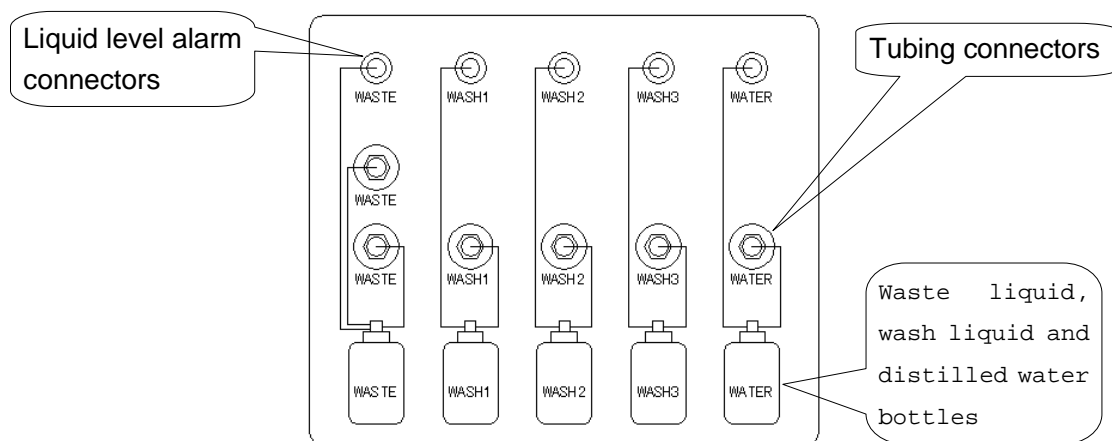

Fig. 2-1 Wiring diagram of tubing and alarm signals

**Note: The instrument works with the principle of atmospheric pressure, so the bottleneck of the waste bottle as well as all tubing interfaces must be sealed up.**

### 2.3 Install the wash head

- Respectively rotate two ends of the dispensing tube and the draining tube to the corresponding colored tube joints.
- Hang the wash head on the left side of the supporting bracket, and make sure that the two pins at side fall into the groove of the supporting bracket.

### 2.4 Start the instrument

- Fill the wash bottles and the distilled water bottle with cleaning wash liquid and distilled water respectively.
- Take out the power line in the accessories bag, and have one end connected to the power inlet of the rear plate while the other end connected to the 220V power supply.
- Start the instrument by pressing the power switch at the back of the instrument.

### 3. Settings and adjustment of the instrument

In the software of Microplate Washer, a system setting menu has been provided for users to set up the system. To make sure that the instrument works normally, you must set up the system properly.

---

**Note: If the system settings are incorrect, it may lead to the result that liquid spills over, plates can not be washed effectively, or wash head be damaged, etc.**

---

After starting the instrument, at first it will initialize the systematic parameters, and check if the programs need upgrading; Then the system primes the pipelines (for parameter setting, please see Section 4.4) with preprogrammed wash liquid. At this moment, press **CANCEL** key to cancel the priming process, or when the selected wash bottle has no liquid, the instrument will automatically cancel the priming process and get into the main interface; finally the instrument automatically gets into the main interface of the system, as shown in Fig. 3-1. The keys **▲**, **▼**, **➡**, **➡** can be pressed respectively to make the menu selection of upwards, downwards, right, and left, and the selected menu will be shown with highlight.







At the main interface, pressing the **START** key will enter a corresponding menu procedure while pressing the **CANCEL** key will show the system LOGO. On the LOGO interface, pressing any key will return to the main interface of the system.

The menu names of ASPR/DISP, PRIME and RINSE indicates that the corresponding keys **ASPR**, **PRIME**, **RINSE** on the keyboard can be used to enter the corresponding menu directly.

Ver1.0e	SN: XXXXXXXX
<b>Plate washing</b>	Plate settings
ASPR/DISP	Switch bottle
PRIME/RINSE	Adv. settings
Incubator	Switch off

Fig. 3-1 Main interface of the system

### 3.1 Advanced settings

Set the systematic parameters, such as LCD contrast ratio, work temperature of the incubator, limit stroke of motor, and system's hang-up time, etc. On the main interface, the keys , ,  and  can be used to select "Adv. settings", and pressing key **START** will enter the advanced settings program, as shown in Fig. 3-2. The keys  and  are used to select the corresponding programs.

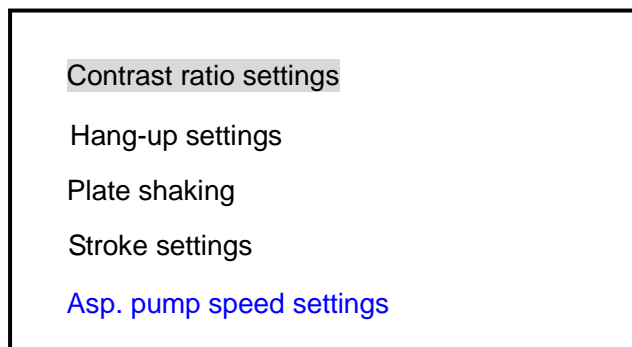



Fig. 3-2 Advanced settings interface

#### 3.1.1 Adjust the LCD contrast ratio

The keys  and  can be used to select "Contrast ratio settings". And pressing key **START** will enter the contrast ratio setting program, as shown in Fig. 3-3.

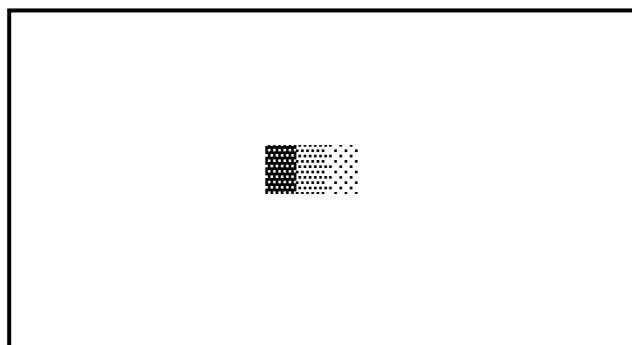



Fig. 3-3 Interface of contrast ratio settings

If the key  is pressed the contrast ratio increases and the color becomes darker; if the key  is pressed the contrast ratio decreases and the color becomes lighter. After adjusting to optimum value, press **START** to finish the adjustment and get back to previous menu. The new value of contrast ratio is saved in the FlashROM of Microplate Washer. When the instrument started next time, the LCD contrast ratio is set up according to the new value. During adjustment, press **CANCEL** to quit without saving.

Microplate Washer has 64 contrast ratio grades.

#### 3.1.2 Hang-up settings

User can set up the hang-up time. Keys  and  are used to increase or decrease time; Pressing

**SELECT** can switch between the operation of changing the time by 1 or 10 minutes. Press **START** to save and quit, and press the key **CANCEL** to quit without saving, as shown in Fig. 3-4.

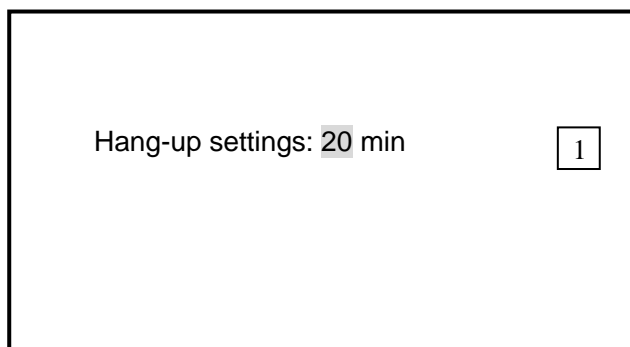

Fig. 3-4 Hang-up settings

If there is no operation within the preprogrammed hang-up time, instrument will rinse the pipeline automatically and get into a hang-up status.

In the hang-up status, press any key to quit and get back to operation; when returned from hang-up status, the instrument will automatically prime pipelines with preprogrammed wash liquid.

### 3.1.3 Plate shaking

The user can shake plate during washing procedure or independently. The **▲** and **▼** keys are used to select "Plate shaking". Press **START** to enter the Plate shaking interface as shown in Fig. 3-5.

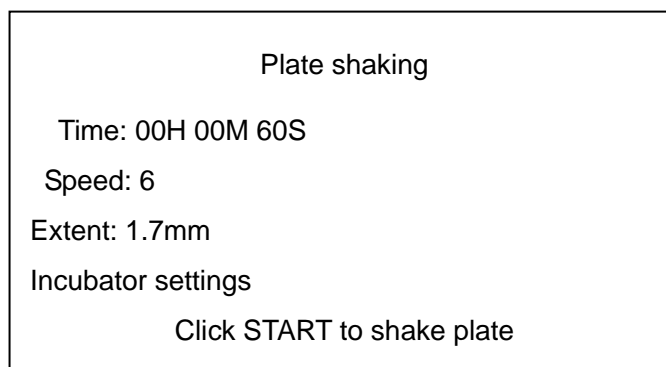

Fig. 3-5 Plate shaking

Use the **▲** and **▼** keys to select Time, Speed, and Extent of plate shaking. And Press **+** and **-** to adjust values. Shaking intensity and time are adjustable. There are 10 levels of Speed, the bigger value, the faster. Extent is the distance of moving back and forth, can be set 0.1-2.0mm. Maximum shaking time is 23H 59M 59S.



Intensity of plate shaking in Plate washing menu depends on intensity set on Plate shaking menu.

In plate shaking menu, incubation settings is also available. For more details about incubation, you can reference to chapter 4-5. Maximum incubation time is 18h. Plate shaking and incubation can be carried out independently.

Press **START** to save changes and shake plate. Shaking time is displayed. Double press **SELECT** key to start counting of incubation time. Press **CANCEL** to quit.



### 3.1.4 Stroke settings

User can adjust the stroke scope of motor on horizontal and vertical directions. Keys  and  are used to select "Stroke Settings", and press  to enter the stroke settings program, as shown in Fig. 3-6.

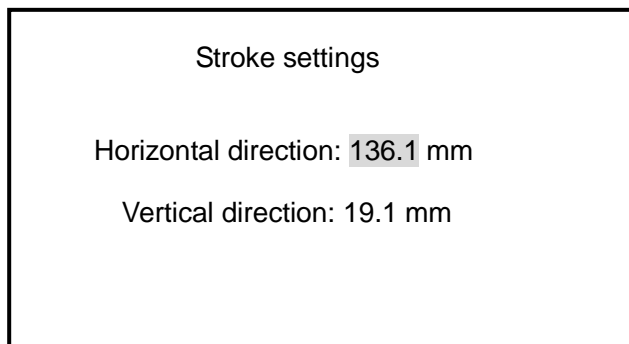















Fig. 3-6 Stroke settings

Keys  and  are used to select "Horizontal direction" or "Vertical direction". Keys  and  are used to adjust the maximum stroke scope.

Press  to save the changes, at the same time, the corresponding motor moves to the preprogrammed position automatically.

Press  to quit without saving.

### 3.1.5 Aspirate pump speed settings

Keys  and  are used to select "Asp. pump speed settings", and press  to enter the pump settings program, as shown in Fig. 3-7. Through keys  and  to set suitable pump speed value. Key  is used to open the pump; Key  is used to close the pump, and the status bar will show "on" or "off" respectively.

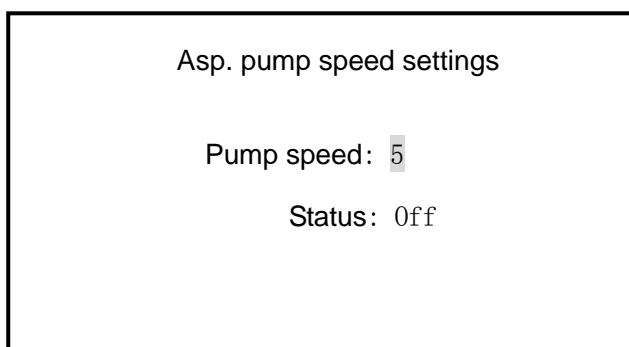









Fig. 3-7 Asp. pump speed settings

---

**Note: Before leaving factory, the instrument has been adjusted to optimum position, so please don't adjust it at will. Otherwise the plate washing effect of the instrument will be influenced.**

---

### 3.2 Plate settings

User can preprogram 10 kinds of plate parameters. Keys , ,  and  are used to select "Plate Settings", and pressing **START** will get into the plate settings program, as shown in Fig. 3-8.  and  are used to select the parameters which need modification, and keys  and  are used to modify relevant parameter values; Press **START** to save and return, and press key **CANCEL** to quit without saving.

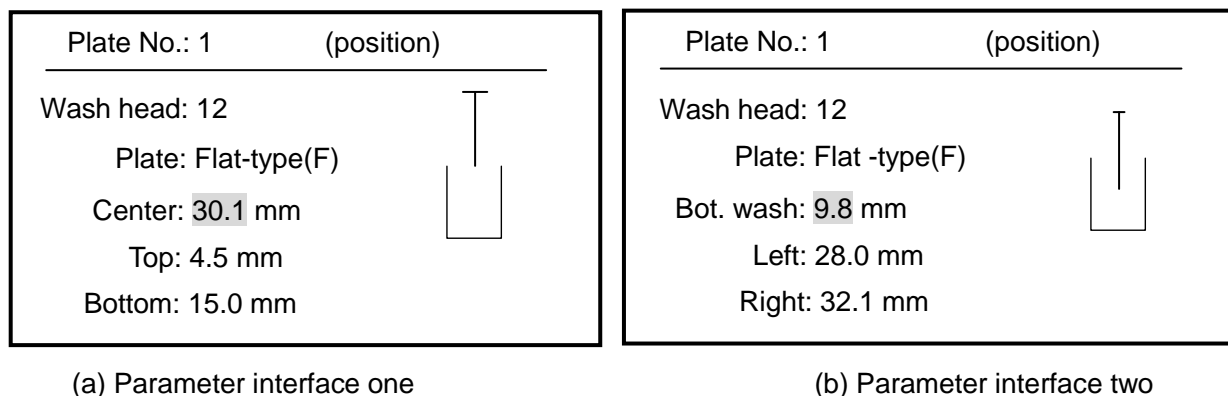













Fig. 3-8 Screen of plate parameter settings

The parameter description and the specific modification operation are stated as follows:

1. Plate No.: Code number of plate type, selected between 1~10;
2. Wash head: 8/12 way wash head can be selected, and the default value is 12;
3. Plate settings: Flat-type (F), U-type (U) and V-type (V) can be selected, and the letters in the brackets are their code numbers. The default setting is Flat-type (F);
4. Center: The centre position. Corresponds to the centre position of the first strip of microwells. Keys  and  are used for adjustment by 0.1mm;
5. Top: Position on the top. Corresponds to the top plane (top aspirate position) of the first strip of microwells. Keys  and  are used for adjustment by 0.1mm;
6. Bottom: Position at the bottom. Corresponds to the bottom position (liquid dispensing position) of the first strip of microwells. Keys  and  are used for adjustment by 0.1mm.
7. Bot. wash: Bottom washing position. Corresponds to the middle position (bottom wash position) in the vertical direction of the first strip of microwells. Keys  and  are used for adjustment by 0.1mm;
8. Left: Left position. Corresponds to the left position of the first strip of microwells. Keys  and  are used for adjustment by 0.1mm;
9. Right: Position on the right side. Corresponds to the right side position of the first strip of microwells. Keys  and  are used for adjustment by 0.1mm;

**Tips of operation by keyboard:**

***In the vertical direction, key  $\uparrow$  means an upward movement while key  $\downarrow$  means a downward movement; in the horizontal direction, key  $\leftarrow$  means a left movement while key  $\rightarrow$  means a right movement.***

---

***Note: The position parameters have to be set up according to the longer pin of wash head and the first strip of microwells of ELISA plates; otherwise the plate washing function can't be completed normally. Meanwhile, the drawing in the right side means the plate type to be select and the current setting position.***

---

### 3.3 Switch bottle

Microplate Washer can switch between three wash bottles conveniently, keys  $\triangle$ ,  $\nabla$ ,  $+$  and  $-$  are used to select "Switch bottle", and pressing **START** will enter the program of switching wash bottles, as shown in Fig. 3-9.

Keys  $\triangle$  and  $\nabla$  are used to select bottle number or switching time; The keys  $+$  and  $-$  are used to modification the switching time. When the bottle number change, in the bottom of the interface shows "switched to bottle X#", as shown in Fig. 3-9 (b). Press **START** to start switching the wash bottle; otherwise current bottle number remains, as shown in Fig. 3-9 (a), wash bottle will not be switched.

During switching procedure, first of all, rinsed the pipelines with distilled water. About the rinse time settings, please refer to section "4.4.2 Rinse". The status shows "Rinse X"; and then prime the pipelines with the wash liquid from the target wash bottle. The status shows "Prime X". During operation, pressing key **CANCEL** will cancel the switching. It will keep using the wash liquid from current wash bottle.

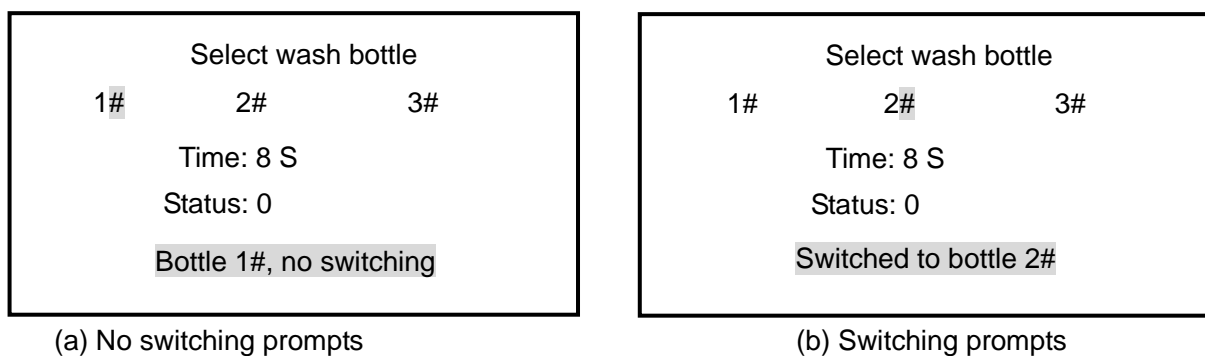
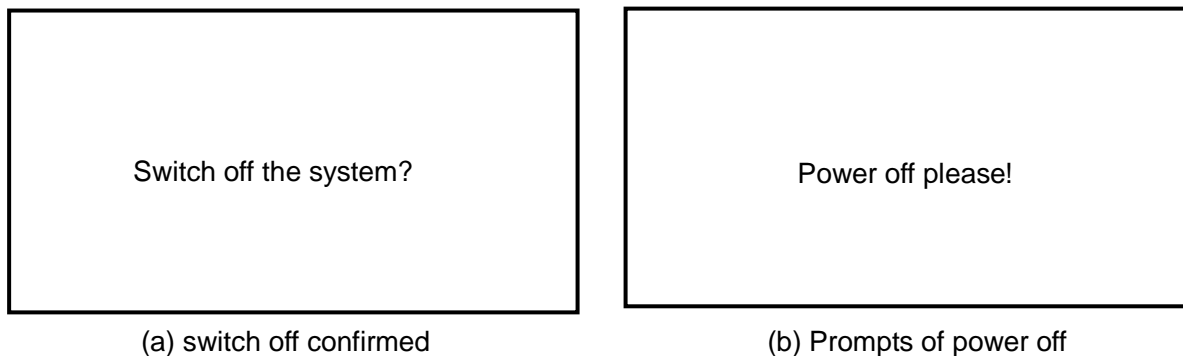

Fig. 3-9 Switching the wash bottles

### 3.4 Turn off the system

If it is confirmed that the plate washing operation has been completed, user can directly switch off the instrument; or the user can select "Switch off " program on the main menu, then the system automatically rinses the pipelines with distilled water, saves the current program code number of the plate washing program, and ask user to switch off the system, as shown in [Fig. 3-10](#).

Press **START** to switch off; press key **CANCEL** to return to the main menu of system and continue with operation.



[Fig. 3-10](#) Switch off the system

---

**Note:** *We strongly suggest that you carry out the "switch off the system" program before switch off the instrument: The system rinses the pipelines automatically with distilled water; saves the current code number of the plate washing program for the purpose of the next use.*

---

## 4. Operation of the instrument

### 4.1 Worktable and ELISA plates

The waiting groove is in the middle of the worktable. When the instrument at stand-by status, the wash head stops in the waiting groove; in front of the groove is a carrying table used to place the ELISA plates.

---

**Warning: Only when the instrument is at stand-by status the *ELISA plates can be put on or taken off from the worktable, otherwise some accident may take place and lead to damage to the instrument or injury to the operator.***

---

Microplate Washer supports ELISA plates of specifications such as 12x8, 12x4, and 8x6, etc., but different wash heads may have limitations to different ELISA plates. The detailed relation is as follows:

Wash head \ ELISA plates	8 pins	12 pins
12x8	Available	Available
12x4	Not available	Available
8x6	Available	Not available

When installing the ELISA plates, pay attention to the direction of the ELISA plates. If 8-way wash head is used, the edges with 8 microwells of the ELISA plate shall be put parallel to the wash head. Similarly, when 12-way wash head is used, the edges with 12 microwells of the ELISA plate shall be put parallel to the wash head.

When installing the ELISA plates, with your right hand catch the two sides of the long edge of the ELISA plate, and from top to bottom, put it into the cross groove, and make the rear edge of the ELISA plate closely contact the rear edge of the nearest groove.





---



**Note: Please operate the instrument strictly according to aforementioned requirements, otherwise it may lead to the fact that the dispensing volume is not correct, the liquid spills over or the wash head is damaged.**

---

### 4.2 Washing the plates

#### 4.2.1 Parameter confirmation



Use , ,  and  to select "Plate washing", press  to enter the parameter confirmation program, as shown in Fig. 4-1. From top to bottom and left to right, the parameters are as follows:

1. Program No.: Code number of the current program, use  and  to select program. Press **SELECT** to switch between changing program number by 1 or 10.
2. Settings: If the parameters of the current program need modification, the parameters can be edited in the "Settings" menu;
3. 1(12-F): Means that the plate type setting with code number of "1" is selected; "12" means a 12-way wash head while "F" means that the position of this program is set up according to F type;
4. Plate: Plate washing methods;
5. 12-Pin: Shows that it is using the setting of 12-way wash head;
6. 350uL: Means that the dispensed liquid volume for each hole is 350uL;
7. 1#: Means that the bottle 1# will be used for washing. About the switching of bottles, please refer to "3.3 Switch bottle";
8. 3 Times: Wash 3 times, the number of times of plate washing;
9. BW-N/BW-Y: No Bottom Washing / Bottom Washing, if the wash time is more than twice (including twice), the previous plate washing cycles have no bottom rinsing; but the last wash cycle has bottom rinsing;
10. Single/Double: Single aspirate / Double aspirate, if the wash time is more than twice (including twice), the previous wash cycles are single aspirate; but the last one is double aspirate;
11. Asp2.0/3.0s: Aspirate 2.0 seconds / 3.0 seconds, if the wash time is more than twice (including twice), the liquid aspirate time of the previous wash cycles are 2 seconds; but in the last cycle the aspirate time is 3 seconds;
12. Soak10/15s: If the wash time is more than twice (including twice), the soak time of the previous wash cycles are 10 seconds; but in the last cycle the soak time is 15 seconds;
13. Shake10/15s: If the wash time is more than twice (including twice), the plate shaking time of the previous wash cycles is 10 seconds; but in the last cycle the shaking time is 15 seconds.

Program No.: 1		Settings	
1 (12-F)	Plate	12-Pin	350uL
1#	3Times	BW-N/BW-Y	
Single /Double		Asp 2.0/3.0 s	
Soak 10/15s		Shk10/15s	
"START" to cont., "CANCEL"			

Fig. 4-1 Confirmation of plate washing parameters

#### 4.2.2 Parameter settings

When the parameters in Fig. 4-1 do not meet your requirement,  and  are used to select

"Settings", and pressing **START** will get into the parameter setting program, as shown in Fig. 4-2:

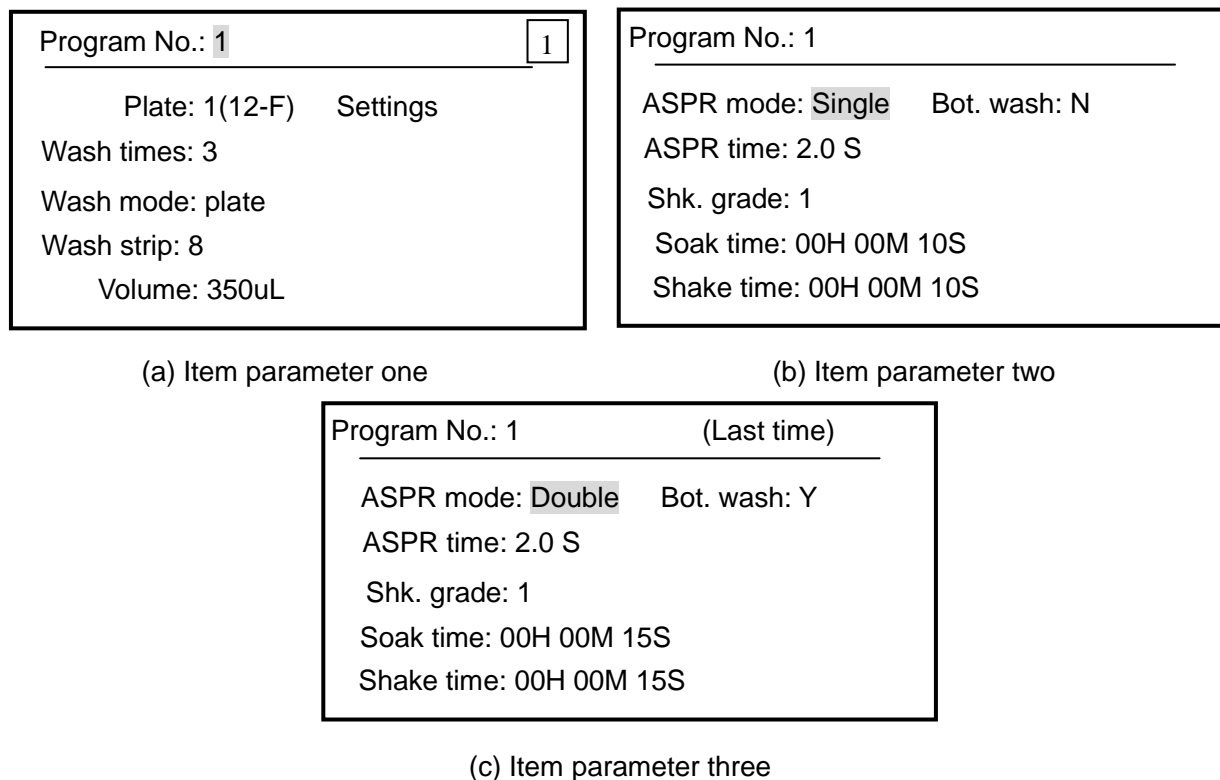

Fig. 4-2 Item parameters

The parameter description and the detailed settings are as follows:

1. Program No.: Code number of the program, keys **+** and **-** can be used to select the program. **SELECT** is used to switch between changing program number by 1 or 10.
2. Plate: Plate type settings, the plate type settings program is respectively 1~10; among them, the letters in the bracket (AA-B): AA means a wash head while B means a plate type (Flat-type, U-type and V-type respectively).
3. Settings: Enter the plate type program settings, and the detailed operation is similar to that of "4.2 Plate setting";
4. Wash times: Set up the number of times of plate washing, which can be set from 1~99 times;
5. Wash Mode: The plate washing method can be selected between plate washing and strip washing;
6. Wash strips: According to the type of the wash head, the number of strips is initialized into 8 or 12 strips (Note: The wash head can only be set up in "Plate Settings", please see "4.2 Plate setting" for details); the "Wash strips" is similar to 4.2.3 "Plate washing operation" and is able to be revised directly;
7. Volume: Dispensing volume, the dispensing volume of wash liquid for each well can be set as 10~3000uL; **SELECT** is used to switch between changing the volume by 1 or 10;
8. ASPR mode: Aspirate method, single aspirate or double aspirate;
9. Bot. wash: Bottom washing, whether the bottom washing is carried out or not;



10. ASPR time: Aspirate time, set up the aspirate time, adjustable from 0.1 to 10 seconds; **SELECT** is used to switch between changing the time by 0.1 or 1;
11. Shk. grade: Plate shaking grade, can be set up from 1~3 grades of plate shaking intensity;
12. Soak time: The time between dispensing of wash liquid completed and starting to aspirate the wash liquid can be set from 0 seconds to 23 hours 59 minutes and 59 seconds;
13. Shake time: Can be set from 0 seconds to 23 hours 59 minutes and 59 seconds;

If the washing time is more than twice (including twice), the system will ask for a parameter setting for the last washing, as shown in Fig. 4-2 (c). The upper right corner of the screen displays "(Last time)", and the detailed parameter setting is the same as items 8~13.

---

**Note:** *When some specific parameters of relatively big scope are set up, key **SELECT** can be used to switch the increase-decrease coefficient to 0.1, 1 or 10 in a flexible way. And show the current increase-decrease coefficient value in the right side of the revised parameters.*

---

#### 4.2.3 Plate washing

---

**Note:** *During the plate washing, open the incubator (set temperature at 25□, 30□ or 37□), the incubating status will display on the top right corner of the screen; three times press **SELECT** key, the incubator works and counts time, then give out alert when time is up.*

---

When the parameters in Fig. 4-1 are confirmed to be correct and the number of the program is selected, the number of the program is highlighted; press **START** to get into the plate washing procedure, as shown in Fig. 4-3. The settings of strip number and position are as follows:

Program No.: 1

---

Strip No.: 8

Position: ■■■■■■

Press "START" to continue!

Fig. 4-3 Main interface of plate washing

"Strip No." means the strip number of plates to be washed. When 12-pin wash head is selected, the strip number can be selected between 1~8 strips; When 8-pin wash head is selected, the strip number can be selected between 1~12 strips. This parameter is the same as the "Wash strip" of 4.2.2 Parameter setting. But it is only for the washing of this time, will not be saved.

"Position" shows the position to be washed, and the keys  and  are used to select the modification setting. Pressing  will confirm the washing while pressing  will cancel the washing.

After confirming the strip numbers and position, put the ELISA plates to be washed on the worktable, and press  to start washing, as shown in Fig. 4-4.

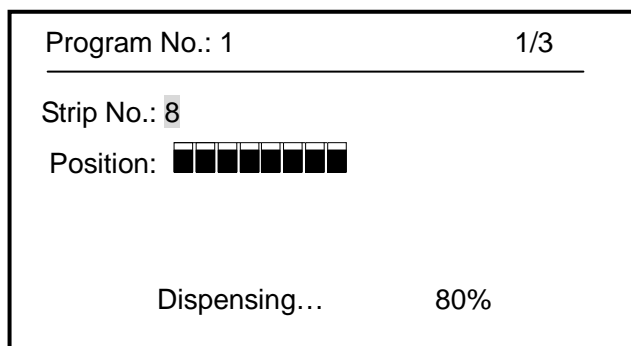

Fig. 4-4 Plate washing status

The "Program No." shows the selected program. At the right side, "1/3" means wash three times and it is the running the first time at present. The middle bottom on the screen will shows status information such as "Draining...", "Bottom washing", "Dispensing...", "Shaking..." and "soaking..." etc.; at the same time the right side shows the percentage or time of the current operation.

During the procedure of plate washing, pressing  will cancel the plate washing, and show error information as shown in Fig. 4-5. After a short while, the system will automatically return to the parameter confirmation screen.

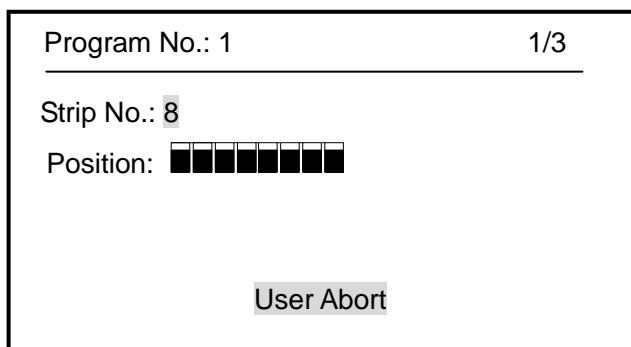

Fig. 4-5 User stopping screen

**Note: During washing procedure, if the washer detects that the wash bottle is empty or the waste bottle is full, it will stop the operation automatically and display the bottle number at the left bottom of screen. At this time, fill corresponding empty wash bottle with wash liquid or pour the waste liquid from waste bottle. Make sure that you have installed the bottle well. Press  to exit, or press  to continue.**

### 4.3 Single aspirate / single dispense

Select the "ASPR/DISP" by keys  $\triangle$ ,  $\nabla$ ,  $\oplus$  and  $\square$ , and pressing **START** will get into the single aspirate / single dispense program, as shown in Fig. 4-6. Press  $\oplus$  and  $\square$  in the options of "Function" to switch between "Single aspirate" and "Single dispense".

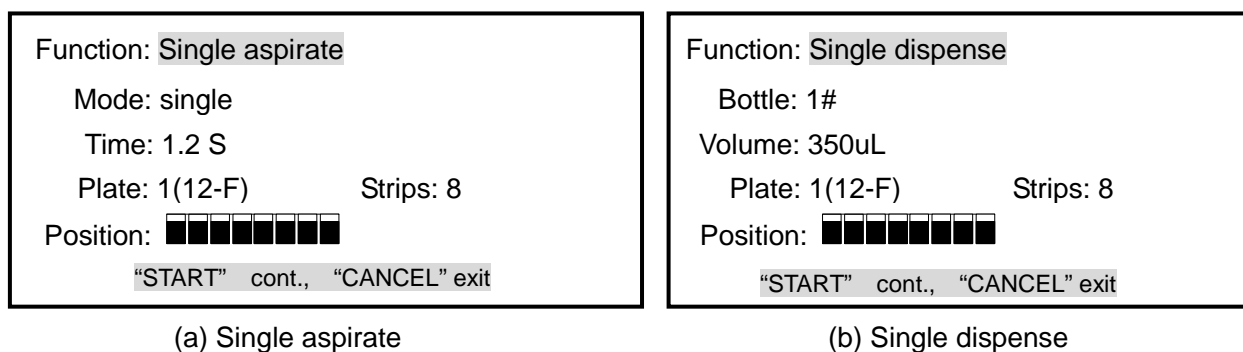

Fig. 4-6 Single aspirate / single dispense interface

#### 4.3.1 Single aspirate

As shown in Fig. 4-6(a), single aspirate means that only aspirate the liquid according to fixed parameters, no dispensing operation. The parameters are as follows:

**Mode:** Indicates the liquid aspirate method which can be selected between single aspirate and double aspirate;

**Time:** The liquid aspirate time, can be set from 0.1 to 10.0 seconds; **SELECT** is used to switch changing the time by 0.1 and 1.

**Plate:** Choose the plate type program. "1" indicates the program number and "(12- F)" means that this program is used for 12-pin wash head and the position is set up according to the flat-type ELISA plates;

**Strips:** Set up the strip number for single aspirate;

**Position:** Liquid aspirate strip settings. Pressing the key  $\oplus$  will confirm the liquid aspirate while pressing the key  $\square$  will cancel the liquid aspirate.

After setting the parameters, press **START** to save and start single aspiration.

#### 4.3.2 Single dispense

As shown in Fig. 4-6(b), the single dispense means that only add liquid to the microwells according to fixed parameters, no aspiration. The parameters are as follows:

**Bottle:** bottle number for dispensing. About switching bottle please refer to "3.3 Switch bottle";

**Volume:** The dispensing volume of wash fluid for single well can be set from 10~3000uL; **SELECT** is used to switch between changing the volume by 1 or 10;

**Plate:** Choose the plate type program. "1" indicates the number of the program while "(12- F)"

means that this program is used for 12-pin wash head and the position is set according to the flat-type ELISA plates;

Strips: Set up the strip number for the single dispense;

Position: strips for dispensing. Press  to confirm dispensing and press  to cancel dispensing;

After setting the parameters, presses  to save and start single dispensing, by the process of dispensing key  will be returned to stop operating.



## 4.4 Prime / Rinse

Select "PRIME/RINSE" menu, use , ,  and , and press **START** to access, as Fig 4-7.



Fig 4-7 PRIME/RINSE menu

### 4.4.1 Prime

Press  and  to select "Prime" and **START** to enter Prime menu.

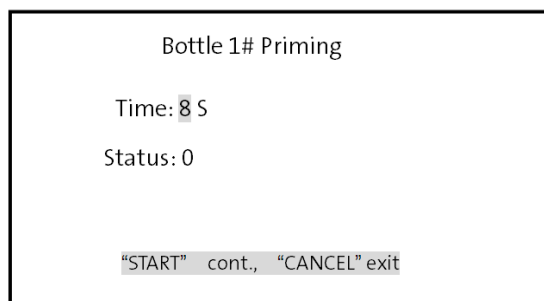

Fig 4-8: Prime interface







After setting the priming time, press **START** to save and start priming. "Status" shows the elapsed priming time. "Bottle 1#" indicates that the liquid in wash bottle 1# is used for priming. Press **CANCEL** to stop and exit

---

**Advice: Set the priming time for 6-8 seconds to enhance accuracy of liquid distribution.**

---

### 4.4.2 Rinse

Select "RINSE" using , ,  and , and press **START** to get into the pipeline rinsing program, as shown in Fig. 4-9. Press keys  and  to revise the rinsing time.

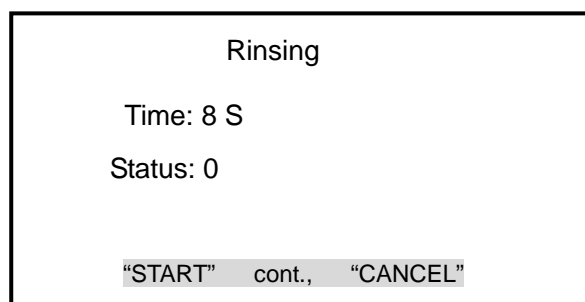

Fig. 4-9 Rinsing interface

Time: The rinsing time, can be set from 1~60 seconds.

After setting the rinsing time, press **START** to save and start rinsing the pipeline. "Status" will show the real rinsing time.

---

***Note: Rinsing and priming time of pipeline should not be too long, usually it shall be about 8 seconds.***

---

## 4.5 Incubator

### 4.5.1 Parameter settings

Use  $\uparrow$ ,  $\downarrow$ ,  $+$  and  $-$  keys to select "Incubator". Press **START** to enter the incubator settings interface, as shown in Fig. 4-10. Select the item using  $\uparrow$  and  $\downarrow$  and press  $+$  and  $-$  to edit the parameters.

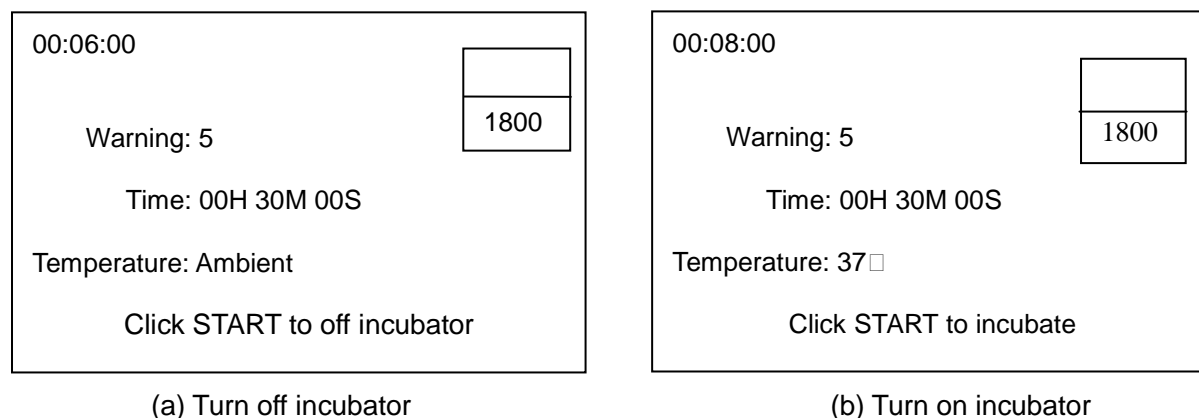

Fig. 4-10 Incubator parameter settings

Warning: when incubation is complete, the system will emit a warning tone. It can be set to "Off" or "1~10", with "Off" meaning no warning and "1-10" indicating the number of warning signals.

Time: incubation time can be set at 0~18 hours. Press the **SELECT** key to switch between 1-second and 10-second increments.

Temperature: the incubation temperature can be set to Ambient, 25, 30 or 37°C.

Press START to save the settings and start the incubation program. Press CANCEL to quit without saving

---

**Note:** After setting the temperature at 25°C, 30°C or 37°C, the incubator works continually. While setting the incubator temperature to "Ambient", the incubator turns off automatically.

---

### 4.5.2 Incubation process

The incubation mode is displayed in the top right corner when the incubator is set to 25, 30 or 37°C as shown in Fig. 4-10-(b). The first row displays the incubation processing time while the second row indicates the programmed incubation time. The incubation mode will not be displayed when the temperature is set to "ambient".

Place a microplate on the incubator and press **SELECT** twice to display the incubation mode (top right corner). When the programmed incubation time has elapsed, the instrument will emit a tone according to the programmed settings.

***Warning: When the incubator is heated, don't touch the incubation plate with hand in order to avoid or prevent scald; furthermore, the incubator is in a state of high-voltage power supply, so when the instrument is working, it is forbidden to touch the incubation plate with hand or conducting objects as ironware etc. in order to avoid electric shock.***

---



## 5. Maintenance

### 5.1 Regular maintenance of the worktable

The worktable usually has remnant liquid, which will corrode the metallic elastic claw. And if there are too much liquid, it might overflow the edge of the worktable and leak into the machine. It is essential to eliminate the remnant liquid frequently on the worktable. A pair of tweezers is used to clip a small piece of absorbent cotton and to clean the remnant liquid. But be careful that the heads of the tweezers can not scratch the surface of the worktable.

---

***Note: Any organic solvent, oil and corrosive liquid can not be used to clean the worktable or the surface of the instrument.***

---

### 5.2 Regular maintenance of the wash head

The wash head is one of core parts of Microplate Washer. Its status will affect the accuracy of the dispensing volume and the quantity of washing, so it is very important to maintain the wash head.

The suspended particulate substance in rinsing liquid will block up the dispensing pipe, so please use fresh rinsing liquid and frequently check whether there is suspended substance existing or not. The dispensing and aspirate pins may be blocked up as a result of the crystallization of the rinsing liquid, so, in order to prevent the crystallization from appearing, be sure to remember to carry out the rinsing (RINSE) operation all the time after the work is completed.

If the dispensing volume of one row is found to be lower than other rows obviously, it shows that the corresponding dispensing pin (thin and short pin) is blocked up; when the remnant liquid volume of a row is found to be higher than other rows obviously, it shows that the corresponding liquid aspirate pin (thick and long pin) is blocked up. When the instrument is in a stand-by status, take off the wash head from the supporting bracket. Use a thin pin to dredge the blocked dispensing or aspirate pins. Then put the wash head back to the supporting arm, and press **RINSE** to rinse it. If the dispensing pin is blocked up seriously, the above-mentioned course need to be repeated many times.

### 5.3 Replacement of the fuse

The specification of the fuse is T3.51AL 250V, and the steps of replacing the fuse are as follows:

- Take out the fuse from the accessory bag.
- Unscrew two fuse caps on the rear plate of the instrument.
- Have the fuse clipped in the middle of the metal reed on the cover, and then fasten the fuse caps onto the fuse wire base.

### 5.4 Treatment of the waste bottle

The sensor within the waste bottle can detect the height of the liquid level. When the waste liquid

reaches a certain height, the software of Microplate Washer will refuse any liquid aspirate operation. At this moment, please deal with the waste liquid in time:

- Hold the bottle lid of the waste bottle, and lift it slightly;
- Hold the bottle body of the waste bottle, and rotate it clockwise until the bottle lid is broken away from the bottle body;
- Dump the waste liquid, and put the bottle body back to the original place;
- Hold the bottle lid of the waste bottle, and cover it on the bottleneck;
- Hold the bottle body of the waste bottle, and rotate it counterclockwise until it is screwed tightly.

---

**Note:** *1. If the bottle lid is fastened too loosely, the air-tightness of the waste bottle can't be ensured and the liquid aspirate effect is influenced; but if the bottle lid is fastened too tightly, it will damage the bottle lid.*

*2. When opening the waste bottle, don't rotate the bottle lid, and you can only rotate the bottle body of the waste bottle so as to prevent the cable of the sensor from being cut off.*

*3. Microplate Washer is a precision instrument, so please pay attention to maintaining it every day.*

*4. The wash head of the instrument is a precision component. To add samples to the ELISA plate, please don't add whole blood or other unexpected things so that the wash head is not blocked up.*

---

## 6. System error and solutions

When there is a system error, Microplate Washer will stop all movement of mechanical parts, and report it to the user. The buzzer gives out a long sound, and the error information shows on the liquid crystal display.

Wash bottle empty, distilled water bottle empty and waste bottle full are the most common error information. Detailed treating methods are as follows:

1. Distilled water bottle empty: refill the distilled water bottle with distilled water.
2. Wash bottle empty: either switch to another wash bottle using "Switch bottle" or refill the current bottle with wash liquid.
3. Waste bottle full: Check the waste bottle. If it is full, empty the bottle and reconnect it. If the bottle is not full, check to make sure that the liquid level sensor cable is connected correctly to the port on the back of the instrument.

---

**Note: 1. When using the instrument, if the user meet an error which can not be solved by yourself or some error appears repeatedly, please get in touch with the seller.**

**2. For the instrument of different editions, its configuration may be subject to a change. But the change does not influence the performance and application of the instrument, so please use it at ease.**

---

## Declaration

We reserve the sole right to the interpretation of this manual

Pictures in this manual are only for example, may be different from the actual displays on the product. They shall not be used for other purposes.

Unless authorized by us with written consent, no person or organization has the right to copy, edit or translation the content of this manual.

## Instructions on optional parts of Microplate Washer

- This manual is written for the operation of Microplate Washer with incubator and 3 wash bottles.
- Product with different version may be different with optional parts, please operate according to following instructions:

**Microplate Washer without incubator:** users don't need to read "4.5 Incubator", system displays "No incubator, please exit!"

**Microplate Washer with only one wash bottle:** users don't need to read "3.3 Switching bottle", system displays "No switching for single channel washer, please exit!"

Different optional parts will not affect the performance of product. If you have any question, please contact our service center or your supplier.